

**Features:**

- Octave bandwidth, specification from 10~3000MHz, usable from 10~3500MHz
- Low noise figure, and high gain
- Low VSWR, unconditional stable
- Small size, low cost
- SMA female connector I/O
- Single DC power supply, low power consumption, internal voltage regulator, operating voltage from +10~+15V
- Operating temperature -40~+85°C, storage temperature -55~+125°C

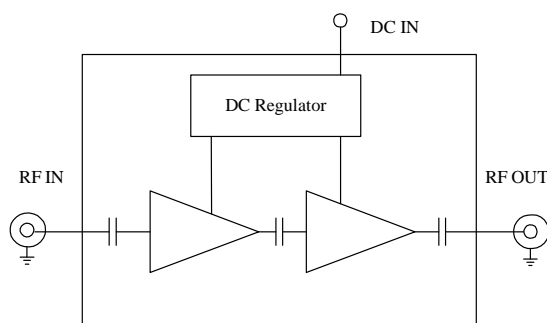

**Functional Diagram**



**Electrical Specifications**

Parameters	Minimum	Typical	Maximum
Frequency Range	10 MHz		3000MHz
Noise Figure (from 50MHz)		1.4 dB	1.65 dB
P-1dB Compression Point	+10dBm	+11 dBm	
Small Signal Gain @25°C	32.5 dB	34dB	36.5 dB
Gain flatness		+/-0.75 dB	+/-1.0 dB
Gain Variation		+/-1.25 dB	
Input VSWR		1.4:1	1.6:1
Output VSWR		1.4:1	1.6:1
Reverse Isolation	40 dB	50dB	
Spurious			-60 dBc
Operating Temperature	-40°C		+85°C
Survival Temperature	-55°C		+125°C
DC Voltage	+10V	+12 V	+15 V
DC Supply Current	85 mA	95 mA	105 mA
In/Out connectors	SMA female		
Size	1.5"x0.85"x0.375		

Mechanical Structure:

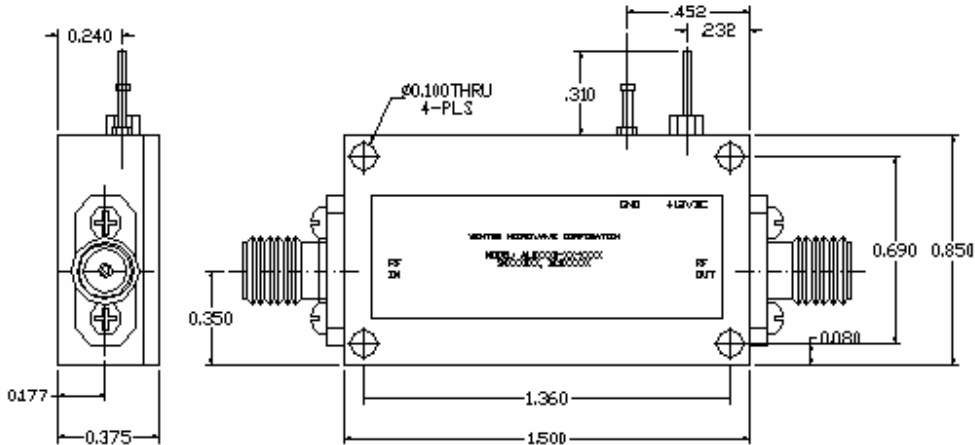

Note: All units in inches.

Typical Test Results:

ABL0300-01-3414 measured gain and return loss vs frequency

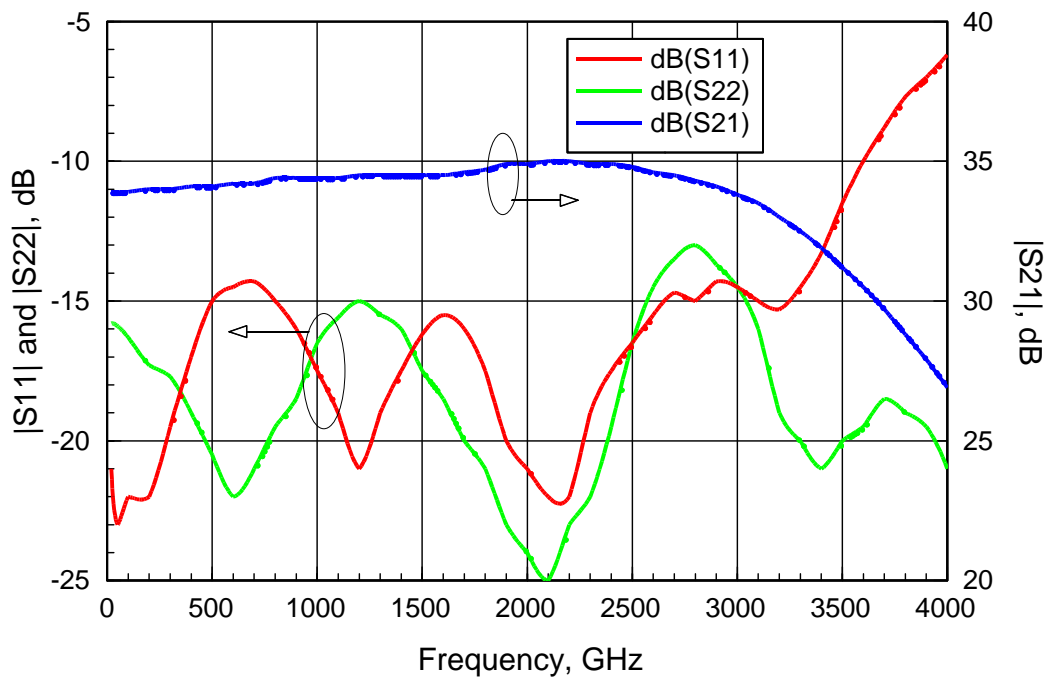

ABL0300-01-3414 Measured Noise Figure vs Frequency

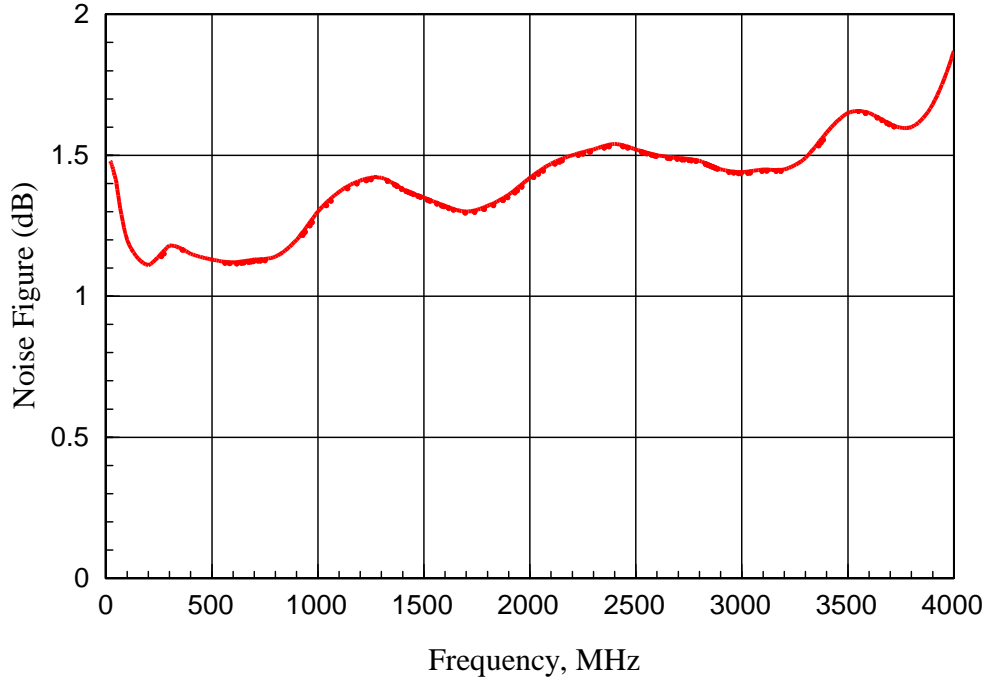

ABL0300-01-3414 Measured Gain and Output Power vs Input Power  
Test Frequency: 100MHz

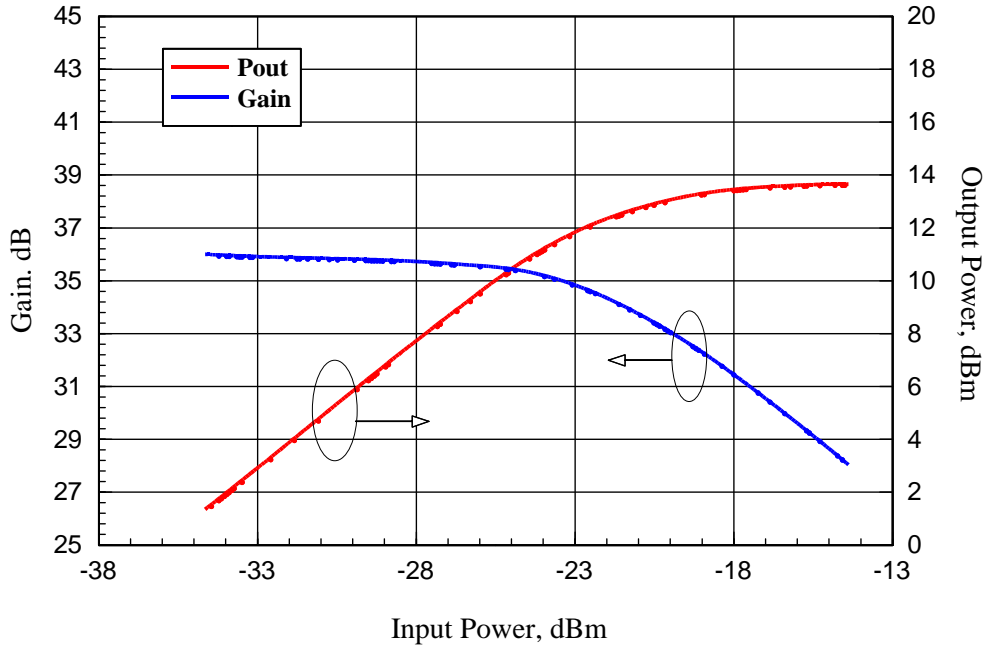

ABL0300-01-3414 Measured Gain and Output Power vs Input Power  
Test Frequency: 1500MHz

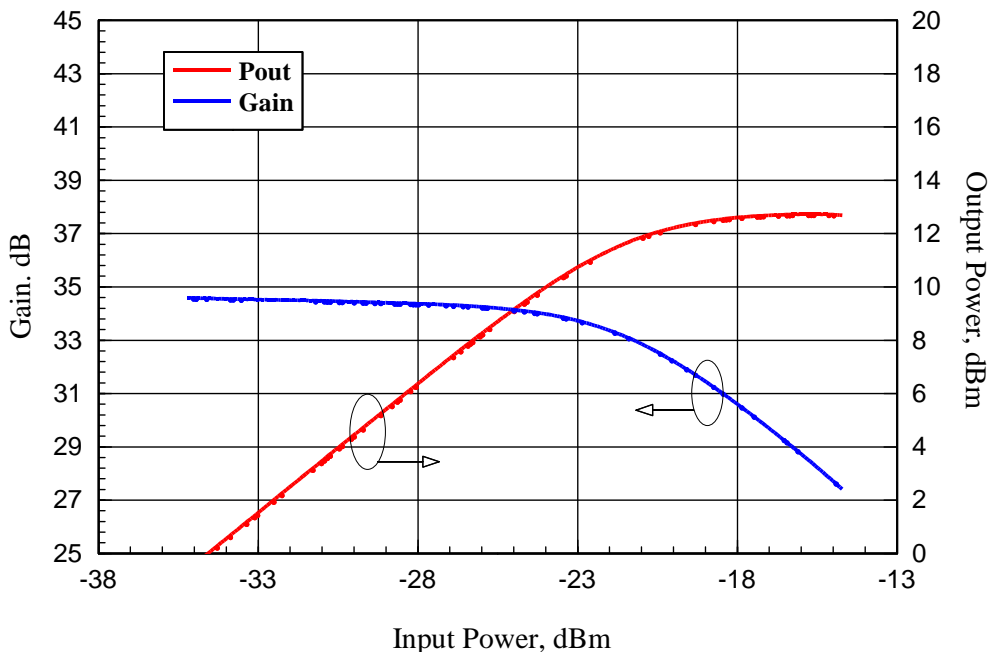

ABL0300-01-3414 Measured Gain and Output Power vs Input Power  
Test Frequency: 3000MHz

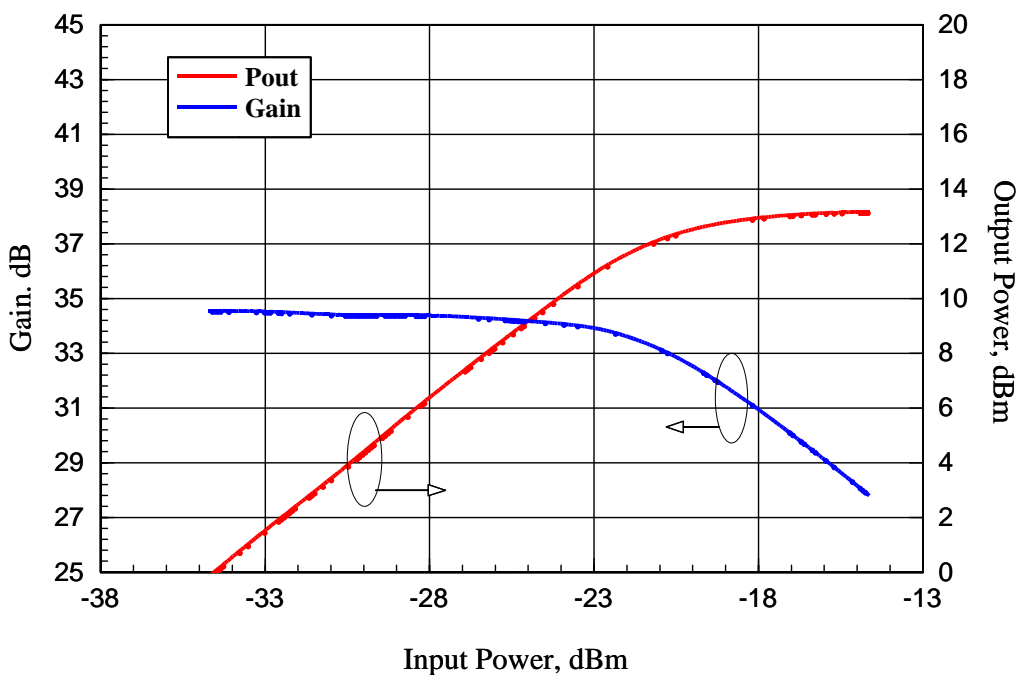



**BROADBAND LOW NOISE AMPLIFIER**  
**ABL0300-01-3414**

---

Absolute Maximum Ratings

DC Voltage	+15V
RF Input Power	+10dBm
Storage Temperature	-55~+125°C
Operating Temperature	-40~+85°C